

PREMIUM MANUAL SCREEN PRINTERS V-2000HD

\$5,513*



V2HD-66

6 station, 6 color, rotary press
w/ Standard size 15" x 17"
(38 x 43 cm) steel pallets

\$5,673

as shown w/ optional service pan & wheels
VSP-WS

25 YEAR
WARRANTY*

V-2000HD features

- RELIABLE 25 Year Warranty
- HEAVY DUTY *Never warp steel pallets* with rubber tops and the new *corner clamp pallet arm*
- USER FRIENDLY *Micro-registration* with wrench free controls & zero backlash
- ADJUSTABLE 6 way screen leveling
- PRECISE Holds accurate multicolor printing registration
- ACCURATE Embedded registration bearings (close to the screen, stays clear of spray tack)
- FLEXIBLE *Prints all heads down*
- SMART Gas lifters with 16 position variable lift strength
- STRONG 12" (30 cm) wide steel rear screen clamps joined by a steel clamp bar for off center clamping & 2.75" (6.9 cm) precision ground center shaft
- DURABLE 3" (7.6 cm) square steel rotor arm with ruler indicator
- INNOVATIVE Elevated Pallets—no need to stretch shirts over the arm (also compatible with quick stretch jacket attachment)
- EXCLUSIVE Zero backlash bearings on screen arm pivot
- CONVENIENT Adjustable micro clamp levers
- EXPANDABLE Upgrade at any time from 1 station 1 color tabletop to 10 station 10 color rotary floor press!

Options

- Additional color and station up-grade packages
- Fast, numbering system attachment
- Super heavy duty print arms
- Pallets: leg, short leg, sleeve, short sleeve, mini, junior, oversized, jumbo, "all over", umbrella, vacuum pallet, custom sizes and so much more available
- Attachments: polo, pocket, above pocket, sweatshirt, cap, quick stretch (jacket hold down)
- Side clamps, removable or fixed
- Locking casters and levelers
- Service pan (for extra storage)



V2P-1517
V2 Pallet arm with standard
15 x 17 pallet.
Shown mounted on rotor arm

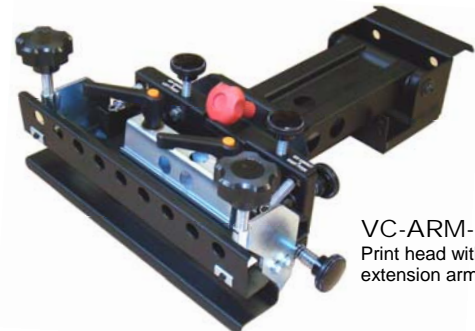

VC-ARM-HD
Print head with
extension arm & hinge

Tabletop models available.

*25 year limited warranty. Gas springs and rubber pallet tops covered for 3 years.

**List Price (USD) for V-2000HD-66 press. Any shown price does NOT include crating and shipping charges. 6% sales tax will be added for PA billing addresses. Prices subject to change without notice.

Vastex International Inc.

610.434.6004 | Toll Free 800.482.7839 | Fax 610.434.6607 | www.vastex.com



V-2000HD_1109

V-2000HD Series Manual Control Press Technical Specifications

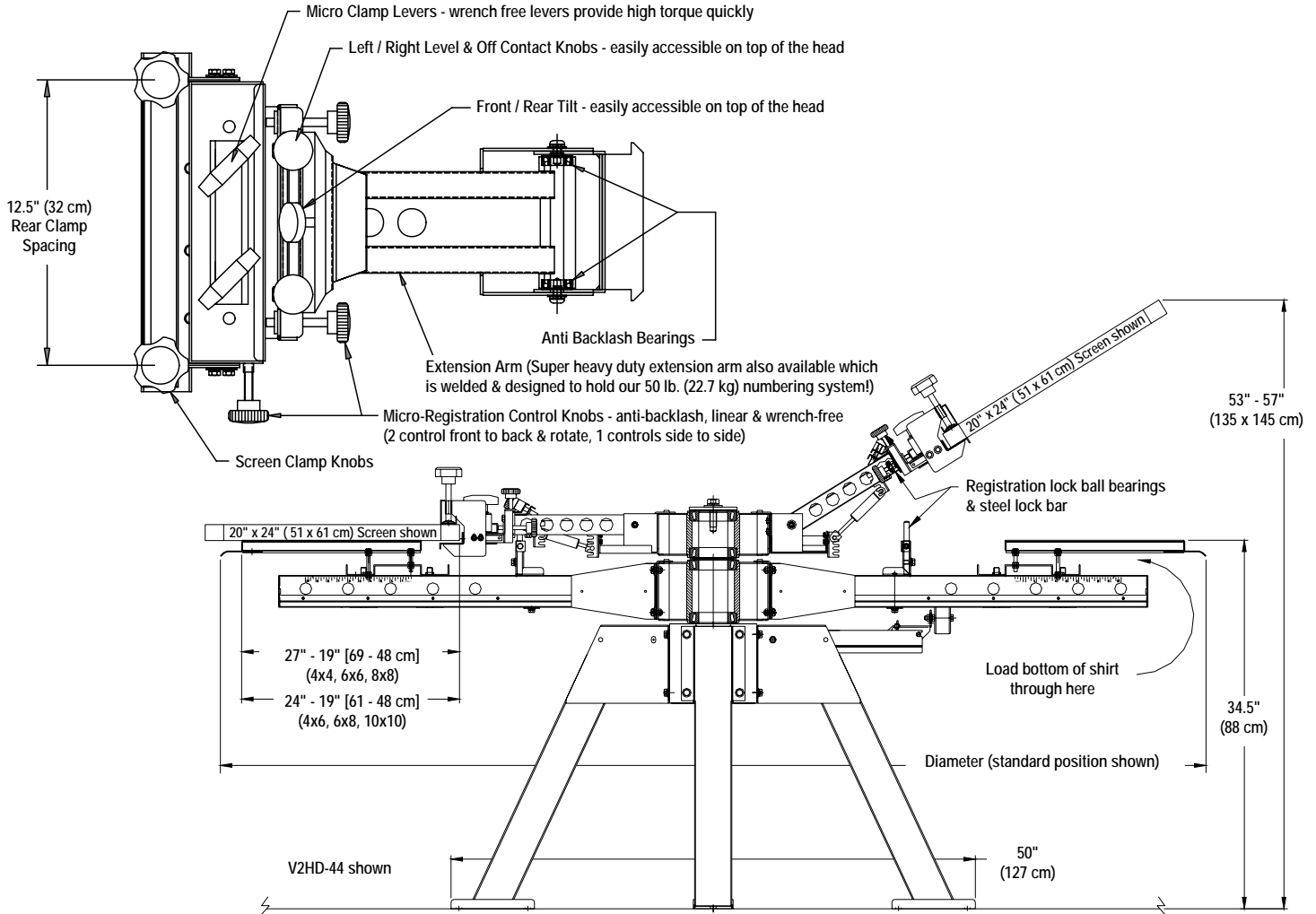

	V2HD-44	V2HD-66	V2HD-88	V2HD-1010
Warranty*	25 Year	25 Year	25 Year	25 Year
Diameter - Standard	91" (231 cm)	99" (252 cm)	109" (277 cm)	131" (333 cm)
Diameter - Fully Extended	105" (267 cm)	111" (282 cm)	121" (307 cm)	137" (348 cm)
Maximum Screen Width	39" (99 cm)	27" (69 cm)	24" (61 cm)	25" (63.5 cm)
w/ optional side clamps	24" (61 cm)	24" (61 cm)	21" (53 cm)	21" (53 cm)
Maximum Screen Weight	14 lbs (6.4 kg)	14 lbs (6.4 kg)	14 lbs (6.4 kg)	14 lbs (6.4 kg)
w/ double gas springs	24 lbs (10.9 kg)	24 lbs (10.9 kg)	24 lbs (10.9 kg)	24 lbs (10.9 kg)
w/SHD arms & extra gas springs	50 lbs (22.7 kg)	50 lbs (22.7 kg)	50 lbs (22.7 kg)	50 lbs (22.7 kg)
Standard Pallet Size	15" x 17" (38 x 43 cm)	15" x 17" (38 x 43 cm)	15" x 17" (38 x 43 cm)	15" x 17" (38 x 43 cm)
Maximum Stock Pallet	20" x 24" (51 x 61 cm)	20" x 24" (51 x 61 cm)	20" x 24" (51 x 61 cm)	20" x 24" (51 x 61 cm)
Height: legs to pallet / w-wheels	34.5" (88 cm) / 38.5" (98 cm)	34.5" (88 cm) / 38.5" (98 cm)	34.5" (88 cm) / 38.5" (98 cm)	34.5" (88 cm) / 38.5" (98 cm)
Unit Weight	400 lbs (182 kg)	550 lbs (250 kg)	750 lbs (340 kg)	1,075 lbs (488 kg)
Shipping Weight**	500 lbs (227 kg)	650 lbs (295 kg)	875 lbs (397 kg)	1,388 lbs (630 kg)
Shipping Dimensions**	50" x 48" x 48" (127 x 122 x 122 cm)	50" x 48" x 48" (127 x 122 x 122 cm)	78" x 48" x 60" (198 x 122 x 152 cm)	68" x 66" x 55" (173 x 168 x 140 cm)
Fits Thru Doorway	Yes - 30" (76 cm)	Yes - 33" (84 cm)	Yes - 33" (84 cm)	No - Requires a dock door
Expandable	To 6, 8 or 10 station / color	To 8 or 10 station / color	To 10 station / color	No - Maximum

*25 year limited warranty. Gas springs and rubber pallet tops covered for 3 years.

**All shipping weights and dimensions are for continental US shipping only. Call for other shipping specifications. Ex-works from Allentown PA.

Shipping weights are approximate and may vary at time of shipping.









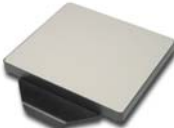

Toll Free: 1.800.482.7839
1.800.4VASTEX

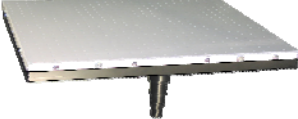
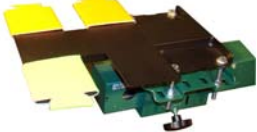

V-2000HD_1109

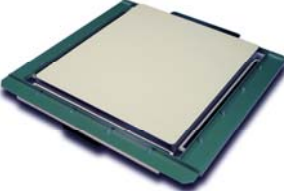
PALLETS & ACCESSORIES

Vastex, quality made in the U.S.A. since 1960

<p>Shirt Pallets: Available in many sizes.</p> 	<p>Mini Pallets</p> 	<p>Clamp on Pallet Adapters</p> 	<p>Zipper Attachments</p> 
<p>Long Leg and Sleeve Pallets</p> 	<p>Short Leg & Sleeve Pallets</p> 	<p>Vacuum Pallet</p> 	<p>Koozie Pallet</p> 
<p>Double Long Sleeve Pallets</p> 	<p>Umbrella Pallet w/ Quick stretch.</p> 	<p>Quick Stretch</p> 	<p>Pallet Arm (V2-ARM) Make your own pallet</p> 

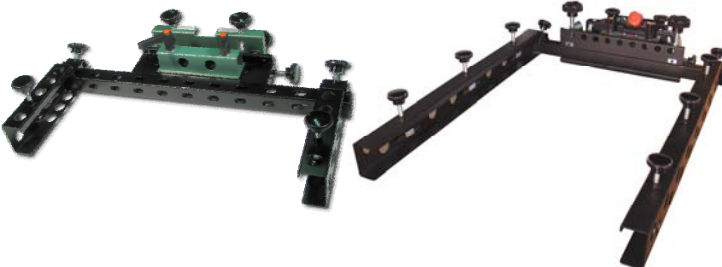
See V-1000 literature for pallet and accessory limitations

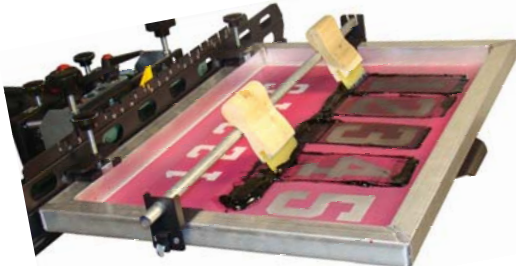
<p>Side Clamp Heads</p> 	<p>Hat Printing Attachment* Available with different cap pallets</p> 
<p>All Over Pallet, up to XL shirts (V2P-AOP-XL)</p>  <p>VASTEX PRINTS ALL OVER!</p> <p>INCLUDES FOAM TOP</p>	<p>The DiGiT Numbering System and Squeegee Rest</p> 

- Never warp, high strength steel construction
 - Quick release and side ruler for easy locating
 - Heat & solvent resistant rubber top (replaceable)
 - Neck guide to aid in garment positioning
 - 4-bolt adjustable, pallet arm (included w/ pallet)
 - Elevated pallet for easy loading
- 25 Year Non-warping Pallet Warranty

Custom Pallets Available!

Download our "Pallets and Accessories Specifications" book for sizes and additional products. VASTEX.COM

